

F. Simon
(Onera)
T. Haase, O. Unruh, M. Pohl
(DLR)
E. Tijs
(Microflown)
R. Wijntjes, H. van der Wal
(NLR)
G. L. Ghiringhelli
(Politecnico di Milano)

E-mail: frank.simon@onera.fr

DOI : 10.12762/2014.AL07-04

Activities of European Research Laboratories Regarding Helicopter Internal Noise

Although the acoustic comfort in helicopter cabins is not subject to European Recommendations regarding aeronautic environmental noise (ACARE 2020), helicopter manufacturers use many resources to improve internal acoustic comfort. This task is particularly difficult because, on the one hand, passengers are in close proximity to the disturbing sources and, on the other hand, the noise frequency range is located in the domain of high sensitivity of the human ear (500-5000 Hz). These activities are often conducted in conjunction with external laboratories specialized in the aeronautic domain.

The purpose of this paper is to describe how different European laboratories (affiliations of the authors), involved in a "Helicopter Garteur Action Group" (AG20), usually address this problem of helicopter internal noise, in particular in terms of design, characterization or active control of vibration applied to helicopter panels, in order to improve acoustic comfort.

Typical measurement techniques and applications of simulation methods are presented to illustrate the activities of laboratories, especially the characterization and optimization of the acoustic behavior of an isolated helicopter panel and, secondly, the evaluation of its effect in a cabin mock-up or in flight. In addition, procedures of active (or semi-active) control are described and applied to the vibro-acoustic transmission of an isolated panel, then to an anti-torque plate of a helicopter mock-up and finally in flight, in order to reduce the noise produced by gear-box vibrations.

Introduction

For several years, aeronautical industries have wished to improve internal acoustic comfort. This is particularly true within the cabin of a helicopter, where passengers are in close proximity to disturbing sources that contribute to interior noise: main and tail rotors, engines, main gearbox (tonal noise) and aerodynamic turbulence (broadband noise) (figure 1).

These sources generate bending vibrations of the entire tail boom, induced vibrations in the cabin at blade passing frequencies (up to 60 Hz), transient vibrations of rotor blades (2-10 Hz) and structure borne noise induced by gear meshing within gear-boxes (500-5000 Hz). External noise (up to 4000 Hz) is also transmitted by acoustic leakages between fuselage and doors.

For a safe, comfortable and healthy helicopter, the following requirements are decisive:

- cabin vibration levels below 0.05 g for steady flight and 0.11g for transition flight (derived from the EC Directive 2002/44/EC on whole-body vibrations);
- cabin noise levels between (80 ÷ 85) dBA for steady flight and 87 dBA for transition flight (derived from the EC Directive 2003/10/EC on interior noise).

It can be noted that these values are higher than in airliner cabins (i.e., 70 dBA) and don't correspond to jet smooth ride comfort (i.e., 0.02 g).

Several European projects have as objectives the reduction of cabin noise and vibration levels: i.e., RHINO (Reduction of Helicopter Interior NOise), FRIENDCOPTER (FRIENDly HeliCOPTER), CREDO (Cabin noise REduction by experimental and numerical Design Optimization) or HELINOVI (HELicopter NOise and Vibration reduction).

It appears that conventional passive systems (trim panels and passive anti-resonance isolation systems, as well as classical vibration

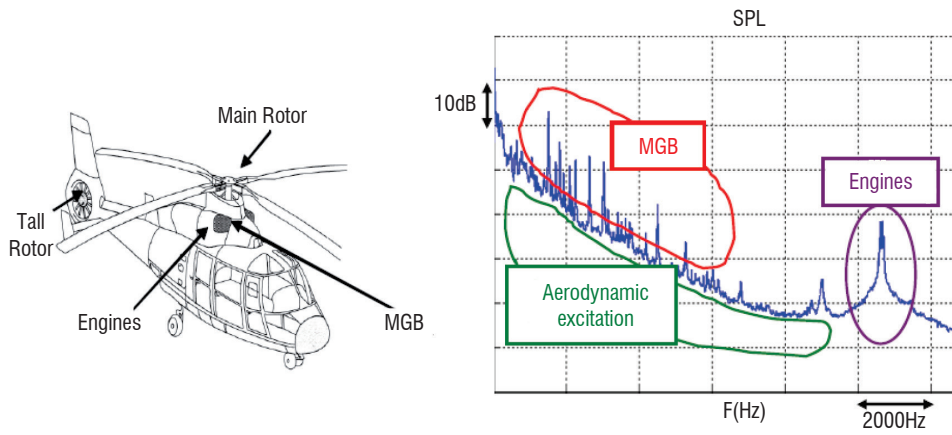

Figure 1 - Main sources with frequency ranges

absorbers and pendulum absorbers) are still the main way to control the acoustics of the cabin, whereas active systems (active vibration and noise control), despite many studies in laboratories since the 1990s, are really applied only in particular cases in complement to passive solutions (structure piezo control, strut vibration control, active noise reduction headrest, etc.). It is due to difficulties to provide algorithm robustness (instability of time convergence), with a spatial reduction (particularly in the medium and high frequency range) and due to a critical balance in terms of added mass and electrical power.

The purpose of this paper is to describe how different European laboratories usually address this problem of helicopter internal noise, in particular in terms of design, characterization or active control of vibration applied to helicopter panels, in order to improve the acoustic comfort. It is based on a think tank, "Helicopter Garteur Action Group", devoted to "Design and characterization of composite trim panels" (AG20).

The activities of the laboratories involved in this group (affiliations of the authors) are presented through the description of mature or in-progress measurement techniques and applications of simulation methods, firstly, to determine and optimize the acoustic behavior of an isolated passive and active helicopter panel and, secondly, to evaluate its effect in a cabin mock-up, or in flight. Finally, in order to reduce the pressure radiated by a helicopter cabin roof (mechanical deck), active control of vibration transmission through the anti-torque plate and cabin roof is also discussed.



Figure 2 - Business configuration in the cabin of a Eurocopter EC 135



Figure 3 - Honeycomb sandwich panel, front side open (left) or closed (right), with absorption layer

Acoustic behavior of an isolated helicopter panel

With regard to passive systems, trim panels in helicopter cabins (figure 2) are generally provided with a core in honeycomb and external layers (laminates) in composite fibers, front side open or closed, sometimes with an absorptive layer (Figure 3)

This light trim assembly is not subjected to a high static force and must simply ensure sufficient stiffness to not be damaged during the helicopter life. Each material fulfills specific tests to be certified: behavior at high temperatures, with humidity, etc. Nevertheless, these components can worsen the internal acoustic comfort.

The Acoustic Transmission Loss (TL) of a trim panel (or fuselage) allows its acoustic efficiency to be quantified. It represents the ratio between incident acoustic power, produced by a diffuse acoustic field, and the acoustic power radiated by the panel (figure 4).

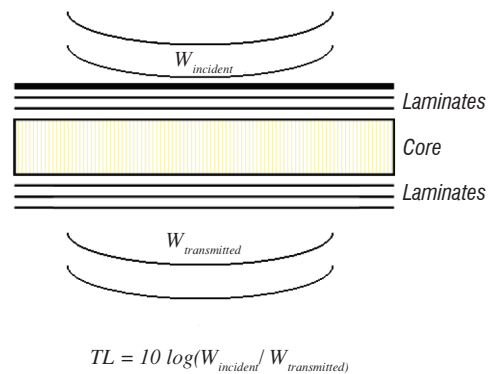

Figure 4 - Acoustic Transmission Loss applied to a trim panel

Measurement of TL (NLR)

This type of parameter is currently measured in a laboratory on an elementary panel, with a controlled excitation. The mounting conditions of the test objects are of great importance for the measured results. Due to practical reasons, the mounting can vary considerably between various labs.

At NLR, the panels tested, representative of a fuselage section are suspended on springs, free from the surrounding structure. The rea-

son for choosing a free-free set-up is to have well defined boundary conditions, in order to preclude possible difficulties in formulating the boundary conditions correctly in a FEM model. Flanking noise has been suppressed adequately by a specially designed panel support structure.

The TL is measured according to the method described in ISO Standard 15186-1, the TL in dB being determined from:

$$TL = SPL_{send} - 6 - SIL_n - 10 \log \left(\frac{S_m}{S} \right) [dB] \quad (1)$$

where SPL_{send} is the sound pressure level in the sending room (in dB re $20 \mu Pa$), measured with a microphone on a rotating boom, SIL_n is the sound intensity level (in dB re $1 pW/m^2$), normal to and averaged over the measuring surface S_m , and S is the area of the test specimen (i.e., the part radiating sound to the receiving room).

The NLR test set-up is shown in figure 5. The volume of the reverberation room is 33 m³, resulting in a diffuse sound field for frequencies of about 500 Hz and higher. In order to reduce the measuring error below 500 Hz due to insufficient diffusivity of the sound field, the TL is determined from successive measurements for different loudspeaker positions.

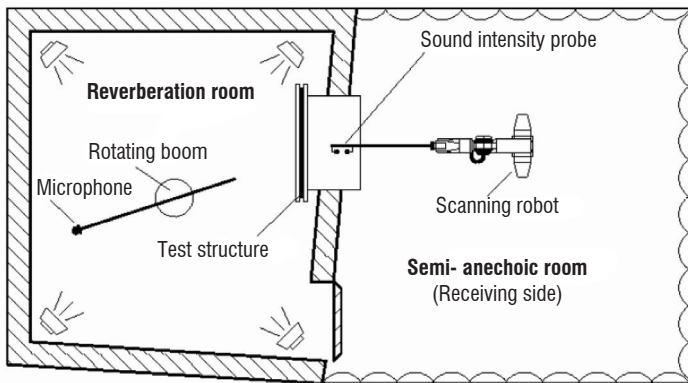

Figure 5 - Set-up for transmission loss measurements on panels (NLR)

walls of the semi-anechoic receiving room, sound absorbing foam is installed around the test opening.

Simulation and passive optimization of TL (DLR / Onera)

In parallel, TL simulations, based on analytic modeling or FE / BE calculation, can be achieved to evaluate the effect of the main parameters or to optimize the nature and arrangement of layers, especially for trim panels.

The TL simulations performed, for example, by DLR, mainly focus on the frequency range from 0 Hz up to 2000 Hz, where active and semi-active methods applied to panels can improve the TL. First of all, the TL simulation, which is based on a FE element calculation and a numerical modeling of the diffuse sound field, is described. One of the main interests of the FE method is to be able to take into account complex boundary conditions for finite panel sizes, which are present in technical applications such as helicopter cabins or aircraft cabins. The frequency constraint of 2000 Hz is due to the computational effort that is needed if the mesh size has to be increased for higher frequencies. Also, panels with foam cores are typically of a higher computational complexity. This is due to the modeling of the core, which must be done with solid elements that have more degrees of freedom than a shell element.

The computational effort is the most limiting method for the FE calculations done at DLR. The advantage of a FE simulation compared to the semi-analytical PIAMCO calculations is the ability to calculate detailed transfer functions of the structure in order to further investigate semi-active control methods.

The simulation of the TL can be described by three steps and is shown in figure 7:

- generating the diffuse sound field by modeling acoustic point sources that are placed on a hemisphere [1] and calculation of the nodal forces that are present on the FE-model;
- harmonic analysis with the FE software ANSYS© of the excited panel and calculation of the normal surface velocities;
- post-processing of the normal surface velocities by the radiation resistance matrix [2];
- calculation of the transmission loss from the incident and radiated sound power (figure 8).

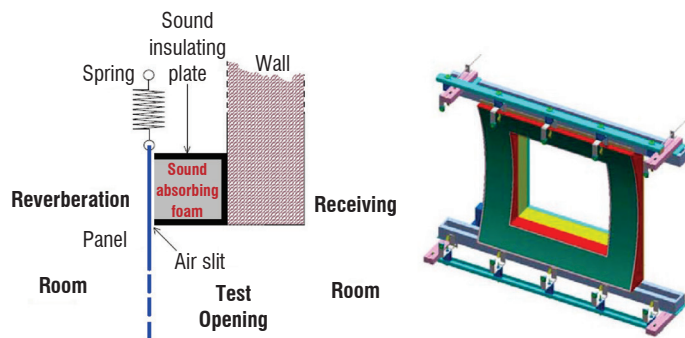

Figure 6 - Principle (left) and CATIA picture (right) of the NLR flanking noise suppression structure

Since the panels are mounted free from the surrounding structure, a special provision has been designed for adequate flanking noise suppression (Figure 6). On all four sides of the test opening, a U-shaped sound insulating structure is mounted, filled with sound absorbing foam.

The panel frames are suspended on springs, which are selected so as to obtain a mass spring resonance frequency of about 5 Hz. The 1 m x 1 m test opening (niche) has a depth of about 1 m. The sound power radiated by the panel is determined from sound intensity measurements over the cross-section of the niche, using a robot to scan the measuring surface. To suppress the effect of reflections on the

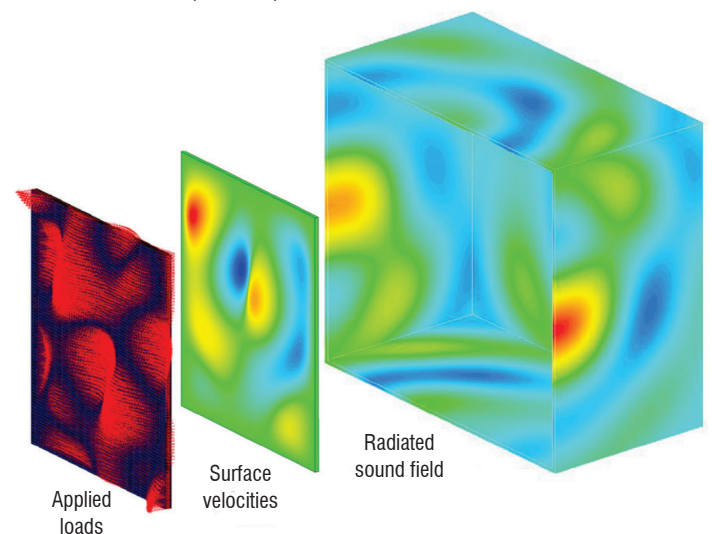

Figure 7 - Steps of the transmission loss simulation at DLR

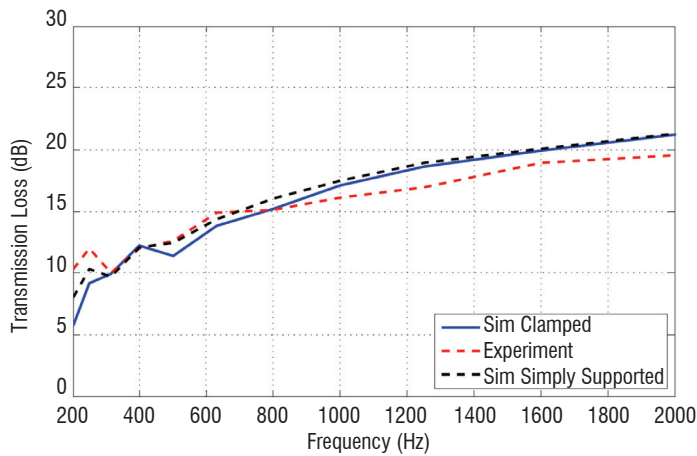

Figure 8 - Simulated (DLR) / experimented (Onera) TL (dB) of typical honeycomb sandwich panel

Nevertheless, to increase the frequency range of interest and because of the CPU time needed for an optimization process, analytical or semi-analytical models are widely used, although suited to an infinite panel size or a finite panel size with simple boundary conditions (simply supported, clamped or free conditions).

The following figure (figure 9) shows an example of a TL simulation result determined by Onera from an optimization process for a honeycomb sandwich pane [3], representative of a trim panel.

The assembly of materials has been defined from a fractional plan using a database, composed of several Nomex honeycomb (with variable thickness), fiber glass, Kevlar, carbon and viscoelastic materials.

The obtained optimal configuration, computed with a semi-analytical model (software PIAMCO [4]), has a maximum global TL in the frequency range of 500-5000 Hz [5] and complies with initial requirements, such as surfacic mass and thickness below 6 kg/m² and 20 mm, and presence of a viscoelastic layer on both sides of the core. The panel surfacic mass and thickness are 6 kg/m² and 8.2 mm, with a core of 5 mm thick.

It appears that, in the mentioned frequency band, the TL is similar to that produced by a steel panel of equal weight. The coincidence frequency, f_c , and the double wall resonance frequency, f_d (with a "dilatation effect" of the panel), appear beyond the band (12 and 18.4 kHz) [6]. Thus, the TL follows only the mass law. Moreover, the high damping provided by the viscoelastic layer (about 20 %) is not efficient beyond the coincidence frequency.

This type of result shows that other trim panel designs must be proposed to avoid the "mass effect", unfavorable to current cabins. For instance, it may be interesting to use foam with open cells, offering less stiffness than honeycombs, to decrease the double wall resonance frequency and to thereby generate a high TL form medium frequency range. Figure 10 shows the simulated and experimental TL of a sandwich panel with an "open cell foam", whose surfacic mass and thickness fulfill the previous requirements. In this case, the double wall resonance frequency of around 550 Hz leads to a TL of about 60 dB at 10 kHz, compared with figure 9. The influence of the transverse Young modulus of foam E_{cz} is brought to the fore to shift the double wall resonance frequency.

We would expect similar curves as in figure 9 and figure 10, up to 2000 Hz, with FE element calculations with DLR tools.

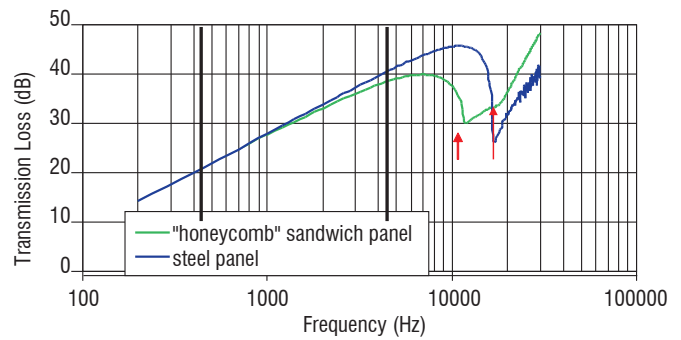

Figure 9 - Simulated TL of optimal "honeycomb" sandwich and steel panels [3] (Onera)

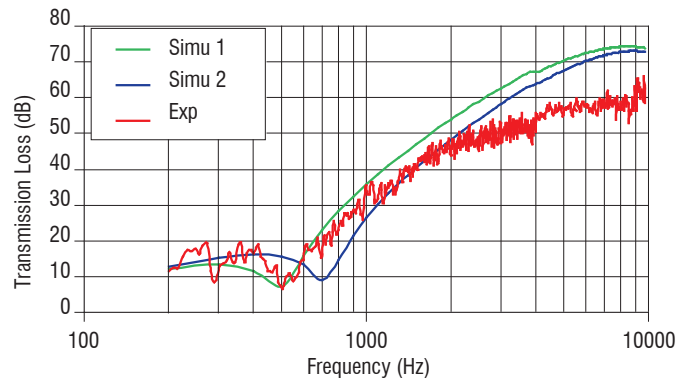

Figure 10 - Simulated / experimental TL of a sandwich panel with "open cell" foam - simu 1: $E_{cz}=0.1$ Mpa - simu 2: $E_{cz}=0.2$ Mpa [3] (Onera)

However, this type of concept proposed by Onera has led Eurocopter to propose improvements compatible to other constraints such as, for example, fire resistance (patent [7]).

Nevertheless using open cell foam can generate a significant reduction of mechanical stiffness. A multi-objective genetic algorithm can then be used to find an optimized panel with a good compromise between acoustical and mechanical properties [8]. That is to say, to perform a tri-objective optimization for a "lightweight stiff acoustic panel". The main drawback is the computing time, but the advantage is the quantity of information obtained.

Active or semi-active control of TL (Onera / DLR)

As a complement to the passive behavior of the optimized trim panel described previously, active or semi-active control techniques have been developed by laboratories to improve the TL of elementary panels in low frequencies (figure 11).

Active isolation is a good solution when a large part of the primary excitation is transmitted to the trim panels through structural attachment points. In helicopters, this is the case with the struts or the frames: the vibrations coming from the gear-box excite the trim panels through their attachment points. The idea is to reduce the incident vibration levels, which excite the trim panels.

The trim panels are usually mounted with soft rubber parts, which filter part of the incident energy. Nevertheless, these passive parts are not efficient enough to drastically reduce the incident vibration levels

and their efficiency is concentrated in the higher frequency range. Moreover, a soft mount induces suspension modes that are added to the primary excitation at low frequencies. An active isolation system is efficient at low frequencies and will complete the passive part.

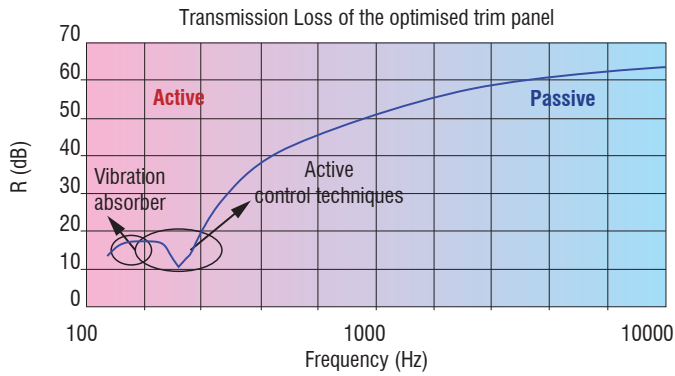

Figure 11- Complementarities of passive and active techniques

Active isolation system consists in replacing the attachments by actuators. The existent passive parts are usually kept. Depending on the vibration levels and the static forces, the actuators used in isolation system can be based on different technologies: hydraulic, magneto-rheological or piezoelectric, for example.

In order to reduce the structural noise and vibrations coming from the trim panel, Active control methods with piezoelectric patches present another solution to add damping in the panel [9][10].

This control approach is termed active structural acoustic control (ASAC), in contrast to active noise control (ANC), where secondary sound sources are used to lower the initial sound field.

Recently, a new approach has been developed to keep the best of these two approaches: semi-passive, or semi-active techniques, according to appellations [11][12][13]. These techniques consist in connecting piezoelectric patches to an electronic circuit. In some cases, the energy of a piezoelectric patch is dissipated in a RLC (resistance, inductance and capacitance) electronic scheme, with a resonant frequency tuned to the target frequency to be reduced.

In DLR, for example, negative capacitance networks are applied to a vibrating panel, in order to increase the total damping: To achieve optimal results, due to the damping of negative capacitance networks, the ASAC pre-design tool [14] is extended by an objective function that calculates the performance of negative capacitance networks. Figure 12 shows a flow chart of the ASAC pre-design tool of the DLR.

The working principle of a shunt damped active structure is presented in figure 13. The piezoelectric patch actuator is used as an energy transducer, which transfers mechanical energy to electrical energy. The electrical energy is dissipated in the electrical domain and the vibrations are thereby damped. For a multi modal system with varying eigenfrequencies, the negative capacitance networks are well suited. The capacitive reactance of the piezoelectric patch transducer is compensated over a wide frequency range, in comparison to simple resonant shunts. This is achieved by a circuit of active impedance converters, which are presented for example in [15][16].

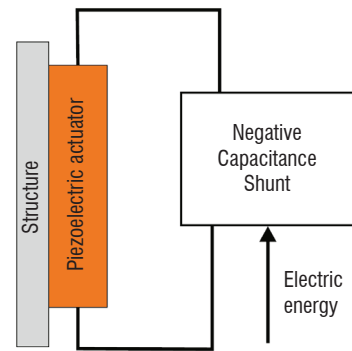

Figure 13 - Principle of a shunt damped structure (DLR)

To achieve a reasonable performance for a high number of modes that are present in plate structures, a custom actuator placement is needed. In a first study, a steel plate was equipped with actuators designed with the ASAC pre-design tool. The calculated actuator placement is presented in figure 14.

Further details of the design and simulation process can be found in [17]. The achieved modal damping improvement is presented in figure 15. It can be seen that an improvement in modal damping up to

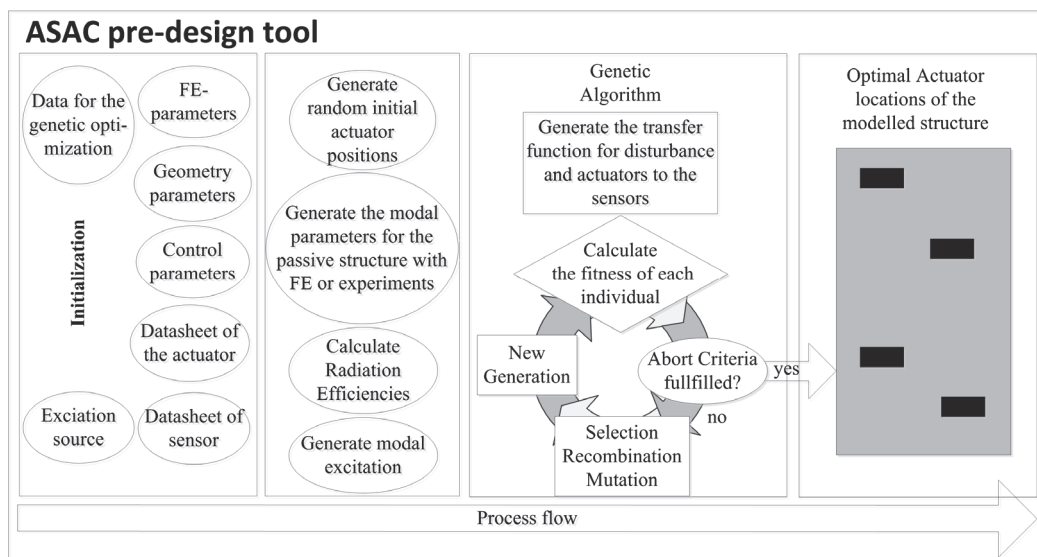

Figure 12 - Flow chart of the ASAC pre-design tool (DLR)

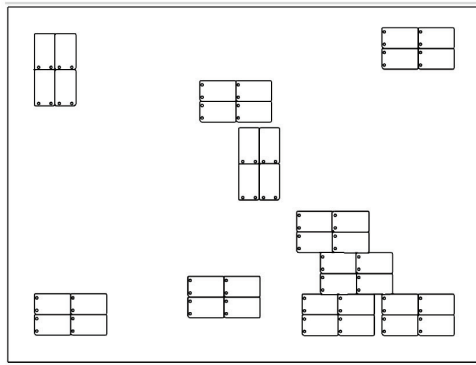

Figure 14 - Designed plate equipped with actuators, sketch and laboratory demonstrator (DLR)

17 dB can be achieved. Also, the prediction of the ASAC pre-design tool compared to the achieved reductions is very good. The applicability of negative capacitance networks to more damped structures must be studied in the GARTEUR AG 20.

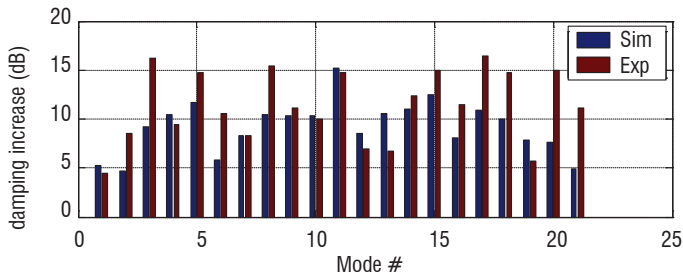

Figure 15 - Damping increase of the shunt damped plate (DLR)

Applications in a cabin mock-up or in a fuselage

Optimizing the configuration of an isolated panel does not guarantee a low noise level in a cabin. Using a cabin mock-up or a real fuselage allows real boundary conditions to be taken into account and allows a realistic loading to be reproduced. Nevertheless, the measured parameters must change: they will be, for instance, acoustic Insertion Loss or reciprocal Transmission Loss. Moreover, active control processes can also be extended to a particular area around the vibration sources: for instance, the mechanical deck that supports the gear-box struts.

Acoustic Insertion Loss in a cabin mock-up (Onera)

At Onera, a mock-up of NH90 cabin (figure 16), made up of carbon frames and Nomex honeycomb sandwich panels placed between fiber-glass and carbon laminates, is equipped with four electrodynamic shakers fixed on the roof of the cabin (mechanical deck), at the same locations as real gear-box struts, to simulate the vibration sources generated by a gear-box (figure 17).

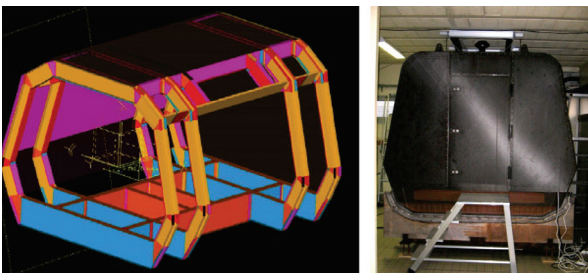

Figure 16 - Right: The strong frames of a cabin mock-up, right: cabin mock-up (Onera)

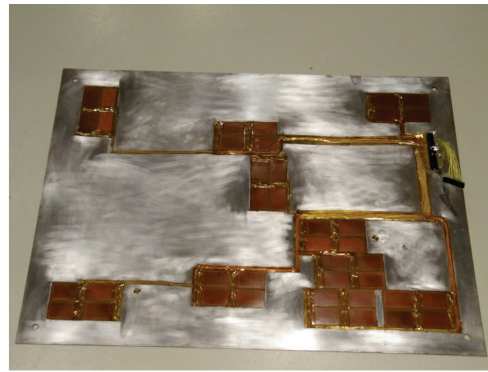

Figure 17 - Mechanical deck of an Onera cabin mock-up, with shakers and loudspeaker

The structural intensity generated by local forces is measured on different composite multi-layered panels (separated by carbon frames) of the mechanical deck [18].

The magnitude of the structural intensity is shown in figure 18, in the case of excitation with 1 or 4 forces. In the 500-3000 Hz frequency band, the energies are propagated mainly towards the middle of the mechanical deck, from the excited source(s), with an important decrease in magnitude along the propagation path (due to high structural damping and the modal coupling).

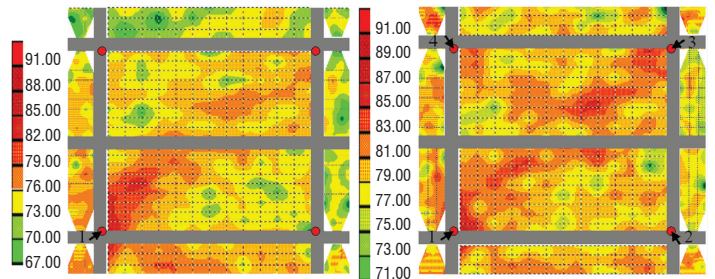

Figure 18 - Structural intensity field on the mechanical deck for the 500-3000 Hz frequency band - Magnitude in dB (ref: 10-12 W/m²) - Excitation by 1 shaker (left) and 4 shakers (right) [18] (Onera)

Figure 19 shows the acoustic pressure field in the cabin 0.2 m away from the mechanical deck, with the four sources between 500 and 3000 Hz. The maximum pressure is focused in the middle of the mechanical deck, which confirms the hypothesis of wave propagation towards the middle.

Nevertheless, a contribution of energy flow through external panels, which can produce side panel excitation and thus a radiating side pressure, can also be noted.

To evaluate the efficiency of a trim panel located under the mechanical deck (figure 20) facing the two main panels, Insertion Loss has

been measured under the ceiling with the acoustic power measurement procedure described in [19][20].

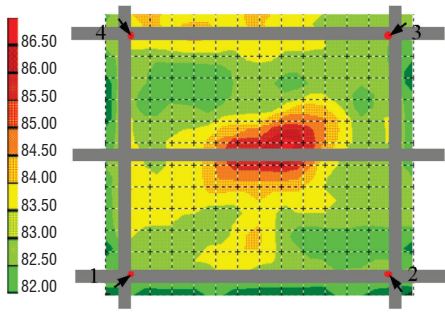

Figure 19 - Nearfield acoustic pressure under the mechanical deck for the 500-3000 Hz frequency band - Magnitude in dB (Ref: 2 10⁻⁵ Pa) - Excitation by 4 shakers [18] (Onera)

The Insertion Loss is defined by:

$$IL = L_{W_2} - L_{W_1} = 10 \log_{10} \left(\frac{W_2}{W_1} \right) \quad [dB] \quad (2)$$

where L_{W_2} and L_{W_1} , are the acoustic powers (dB) with and without panel, respectively.

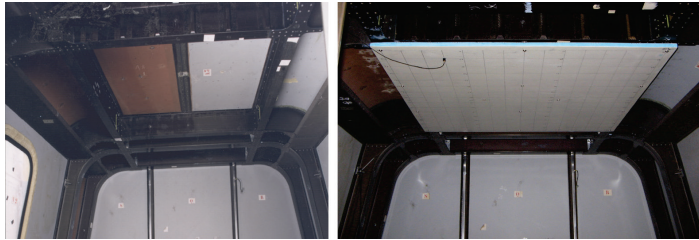

Figure 20 - Ceiling of Onera cabin mock-up without (left) and with trim panel (right)

Two types of trim panels have been tested, one called a "usual" trim panel with a honeycomb and the other called an "optimized" trim panel, with thick foam to have a "dilatation effect" in the medium frequency range (figure 21).

Comparisons are shown in figure 22, in the 1/3 octave frequency bands.

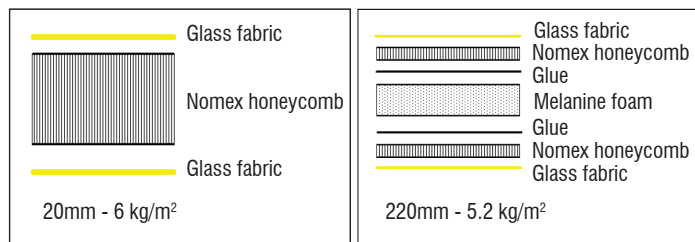

Figure 21 - Example of the usual trim panel (left) and optimized trim panel (right) (Onera)

First, we compare the acoustic powers without panel and with the "usual" helicopter panel. It can be noted that the Insertion Loss increases with the frequency. Nevertheless, from 1/3 octave 5000 Hz, acoustic power due to the presence of "usual" panel is negative. This can be explained by a contribution of external acoustic sources in the cabin (radiating from other panels) whose acoustic power is much higher than the acoustic power radiated by the panel. The behavior of the optimized panel, excited by the pressure radiation of the mechanical deck, is consistent compared to the simulated TL, with a decrease of radiated power from 1/3 octave

630 Hz. From 1/3 octave 1250 Hz, the acoustic power becomes too low to compensate for the external acoustic power produced by other sources.

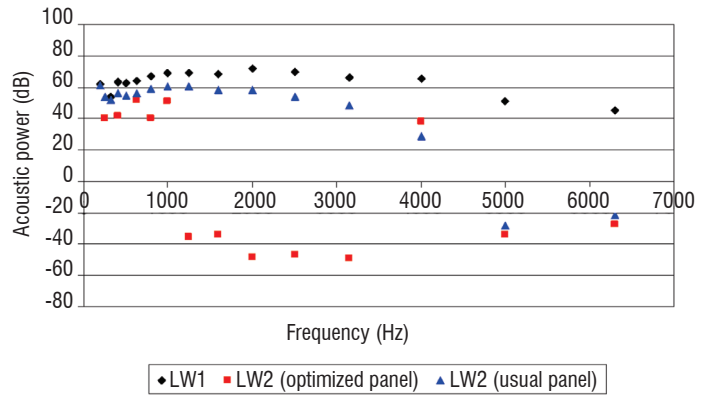

Figure 22 - Acoustic powers (dB) without and with trim panels (200-6300 Hz) (Onera)

We can deduce that the optimized panel can generate a higher Insertion Loss than the usual panel, for a similar thickness and surface mass (particularly from 1/3 octave 1250 Hz).

Nevertheless, these results show that the internal noise can come from pressure radiating from adjacent walls, even if only the mechanical deck is excited by vibration sources, which is consistent with structural intensity propagation.

Vibro-acoustic characterization in a real fuselage (NLR / Politecnico di Milano)

As seen previously, simplified mock-ups can be used for preliminary testing activities, but they may not be fully representative.

As in a laboratory set-up, the reciprocal TL measurement can be performed on a complete fuselage with a source inside the mock-up having a known volume velocity and microphones (normal derivatives) on the exterior side of (part of) the fuselage (figure 23).

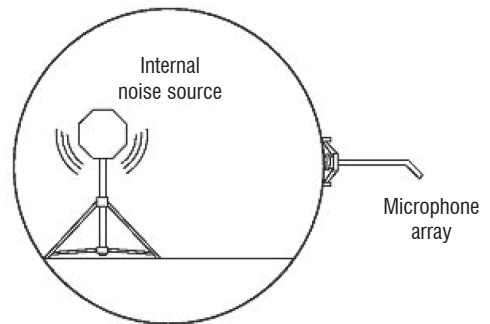

Figure 23 - Reciprocal TL measurement (NLR)



Figure 24 - Array configurations, left: arc, right: row (NLR)

In NLR, a dodecahedron is used as the sound source. The pressures on the exterior side of the fuselage can be measured with different array configurations, such as an arc around the fuselage, or a row of microphones turned around the fuselage (figure 24).

Similarly, Agusta-Westland and Politecnico di Milano built a ground based facility, suitable for experimental activities on internal noise, using an actual helicopter fuselage, although an old one, therefore not representative of current design and manufacturing technologies: it consists in the fuselage of an A109A [21], grounded at three points; main and tail rotors, as well as engines are not installed, while the actual gear-box is installed with actual structural fixtures; in order to naturally reproduce noise due to gear meshing, it is powered by means of electric engines and an aerodynamic brake is used to reproduce the loading effect of gear tooth meshing. The cabin is in green configuration, without any internal equipment and sound treatments.

Most experiments and data presented hereafter have been carried out and collected within the framework of the European IP Friend-copter.



Figure 25 - Left: Helicopter mock-up, right: aerodynamic brake [21] (Politecnico di Milano)

Despite an installed power lower than the actual one, the dynamic behavior (medium-high frequency vibrations and noise) is quite similar as that for in-flight measurement, although still lower, as depicted in the following figure, which shows the acceleration at one of the attachments of the anti-torque plate at audio frequencies. Thus, the mock-up can be validated as a test-bench.

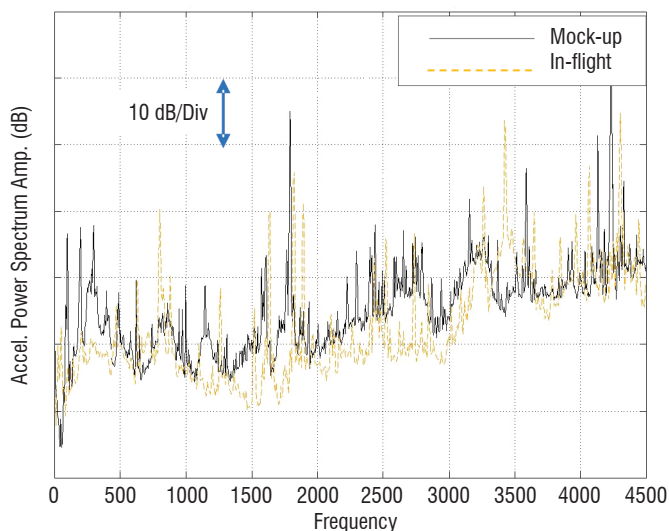

Figure 26 - Comparison of anti-torque plate attachment acceleration: in flight vs. mock-up (Politecnico di Milano)

Thanks to the availability of this test rig an extensive study can be carried out; some of these experiments aimed at understanding the

complex dynamics of the cabin structure are described in the following page. Laser scanner measurement has been carried out, in order to identify operational deflection shapes of the cabin walls, with particular attention to the cabin roof.

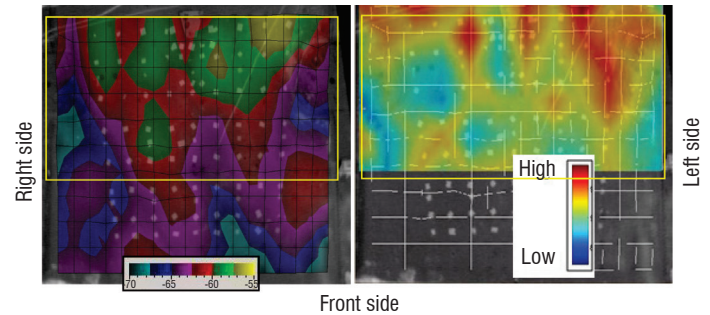

Figure 27 - Comparison between the wall speed (left) and the noise map (right) in the 1600 Hz band (Politecnico di Milano)

On the left side of Figure 27, the operational deflection shape of the rear part of the cabin roof is presented for a 1600 Hz frequency. It is compared with the acoustic map, measured 20 cm from the wall, in the same area.

Due to the interference of reflected waves in the closed field, the noise exhibits a very irregular behavior. This could make many actions critical, e.g., the placing of noise error sensors.

Application of the active control of gear-box vibration transmission (Politecnico di Milano)

The design and tuning of active control systems can also benefit from the availability of test rigs. The following figure shows an example of installation applied to the active control of acceleration, based on a MIMO FXLMS adaptive algorithm, with piezoceramic patches and accelerometers on the anti-torque plate.

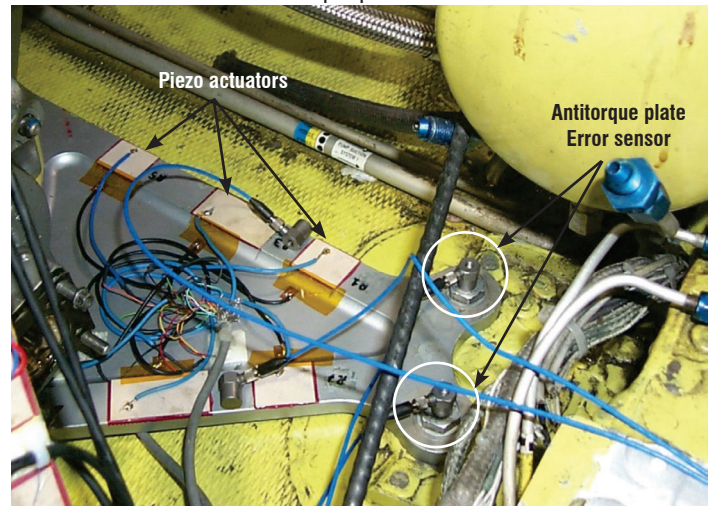

Figure 28 - Installation of piezoceramic patches on the anti-torque plate [21] (Politecnico di Milano)

Due to not yet fully solved problems in adopting noise - or mixed - error signals, structural control is adopted; the results confirm those of the literature experiments: a good structural effect, with a nearly complete rejection of the disturbance and a hardly relevant noise improvement.

As shown by figure 29 for the attachment points (strut and ATP), the error signal is reduced at the controlled frequencies.

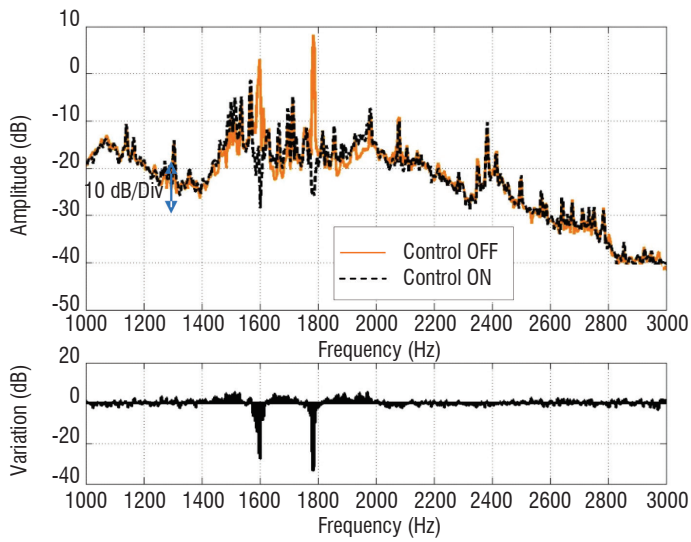

Figure 29 - Acceleration (Control On-Off) at error point – reference value for dB: 1m/s² (Politecnico di Milano)

In the acoustic map presented in figure 30, one can appreciate that, at the 1600 Hz tonal disturbances, most of the rear part of the cabin exhibits a reduction (up to 10 dB), while at a few points the noise level increases. The comparison of individual time averaged SPL levels at the measurement points (figure 31) shows that, at most of these, the noise is reduced; furthermore, it is possible to appreciate how the active control produces a smoother SPL behavior with smaller discrepancies between close points.

It can be noted in [21] that a mean reduction of 3 dB is obtained for each target frequency band, over the whole measurement area.

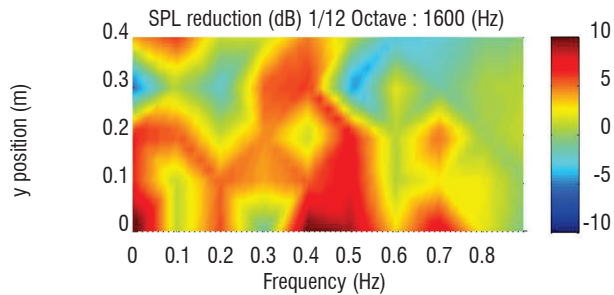

Figure 30 - Map of acoustic reduction due to active control at 1600 Hz (rear cabin)

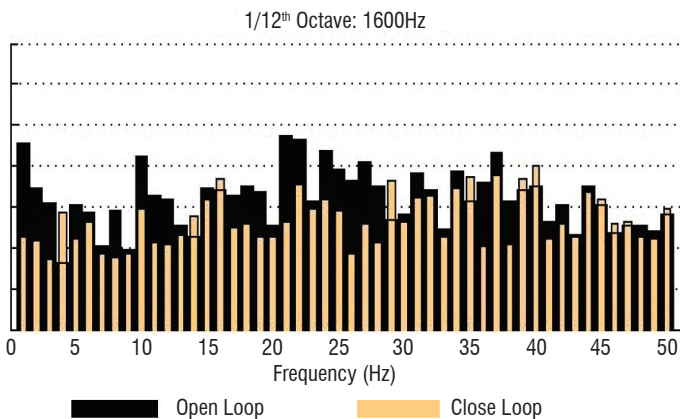

Figure 31 - Time averaged SPL (1600 Hz) (Control On-Off)

Applications in flight tests

Once the passive concepts, or active control techniques, have been tested in the laboratory or in a mock-up, new tests can be conducted in flight, with specific requirements (sound leaks, noise of the turbulent boundary layer, limited added weight, low coherence between signals, etc.). Some examples of application in flight are given below.

Integration of optimized trim panel and active control systems in a helicopter cabin (Onera)

In accordance with previous Onera simulations of TL, a helicopter trim roof is manufactured by Onera with “open cell” panel composition (figure 32, table 1).

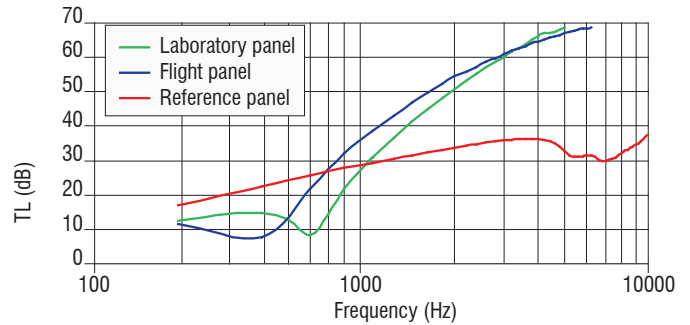

Figure 32 - Simulated TL of a laboratory panel/ flight panel [22] (Onera)

characteristics	Laboratory panel	Flight panel	Reference panel
Surfacic mass (kg/m ²)	5.3	~5.4	~9
Thickness (mm)	10.5	18	10.7

Table 1 - Characteristics of laboratory, flight and reference panel (Onera)

This structure is mounted under the mechanical deck of an EC Dauphin, with elastomeric mounts to limit the transmission of vibration (figure 33). This panel must theoretically improve the TL between 400 and 4000 Hz. The TL of a heavier damped panel with, among other layers, a Nomex honeycomb core and a viscoelastic layer (9 kg/m² for 10.7 mm in thickness), is also presented. This reference panel, with its mass behavior, is less interesting from 700 Hz, with a difference of about 30 to 40 dB at high frequencies.

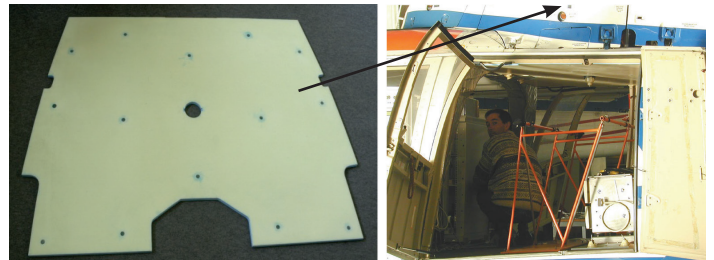

Figure 33 - Trim roof with location of the elastomeric mounts (left) and EC Dauphin cabin with trim roof [22] (Onera)

In the Dauphin cabin, there is an acoustic pressure field with tones (fundamental and harmonic frequencies) produced by 6 main sources with gears, that is to say, 4 stages of the main gear-box, the rear “fenestron” and the fan [5].

We compare the acoustic level pressure, averaged from 6 microphones in cabin, without trim panel and with the “open cell” or “reference” panels (figure 34). The tests have been conducted by Onera for a stationary flight at 85 % of maximum torque.

In table 2, the acoustic reduction at the main tones and the global reduction between 300 and 5000 Hz are shown, with the presence of the “open cell” panel. It can be noted that, contrary to the simulations (table 1), the pressure level is similar with the two types of trim panel. These are efficient from 300 Hz and reduce the aerodynamic pressure and the gear tones (except for the rear “fenestron”). Nevertheless, the reduction reaches, globally, 6.5 dB, which is much lower than in the laboratory.

The “reference” panel, thanks to its high mass, and the “open cell” panel, because of the “double wall” effect, can be assumed to reduce the pressure in the cabin, up to the level produced by the other acoustic transmission paths, such as the side doors or the back surface, which are insufficiently treated by materials.

This type of result, in accordance with tests in the Onera Cabin Mock-up, has questioned the assumption of “major radiation from the roof panel excited by the mechanical deck” proposed in [5] and justify the development of a metrological tool, able to yield information on acoustic radiating areas in the cabin [23][24], in order to target appropriate acoustic passive or active solutions.

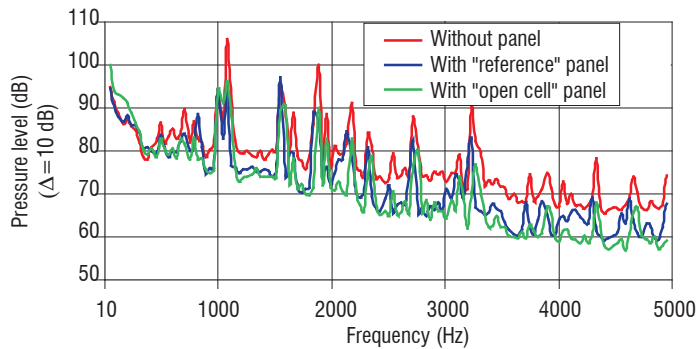

Figure 34 - Averaged pressure level in the Dauphin cabin (dB) - Stationary flight at 85 % of the maximum torque[22] (Onera)

	Tone 1	Tone 2 Fenestron	Tone 3 Stage 4	Tone 4 Stage 3	Tone 5 Stage 2	Tone 6 Stage 4	Tone 7	Global
Frequency (Hz)	708	1001	1074	1550	1880	2176	3235	300-5000
Reduction (dB)	5.3	-0.7	8	3	10	8.6	12.6	6.5

Table 2 - Reduction of the pressure level in the cabin with an “open cell” panel (dB) - Stationary flight at 85 % of the maximum torque [22] (Onera)

However, recently, in order to study internal noise comfort improvement for an EC155 helicopter, Caillet et al. [25] determined the acoustic radiating of cabin panels with Nearfield Acoustic Holography applied in front of each cabin surface (to measure normal velocity field), coupled with a GRIM software (ICARE based on Neumann Green functions GV computed with a beam tracing algorithm [26]) to calculate the sound pressure at any point in the cabin (figure 35).

It appeared (figure 36) that, although the highest contribution in the dB SIL4 frequency range was due to the roof panels, contributions of rear,

right and left side panels was significant. Moreover, dissymmetry of side contributions could be explained by the dissymmetry of the MGB struts loads and by significant leaks measured on the right-hand side panels.

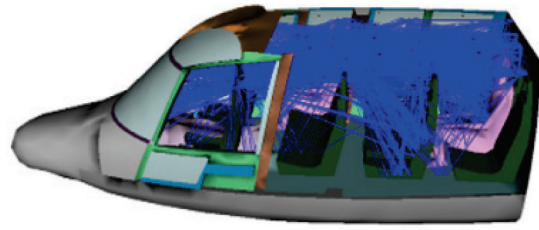

Figure 35 - Example of beam tracing calculation result with ICARE [25]

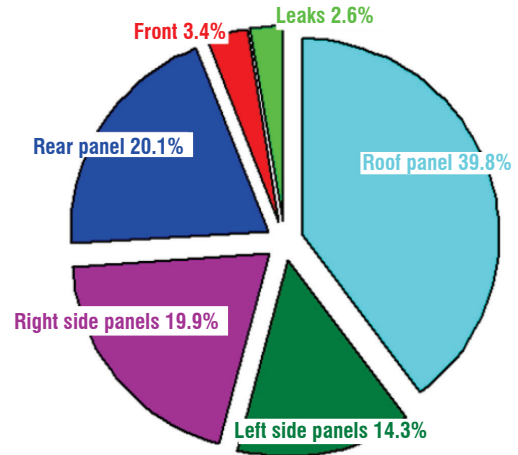

Figure 36 - Average contribution in the EC155 cabin dB SIL4 [25]

Finally, in parallel to tests conducted with an optimized trim panel under the mechanical deck, active control processes are applied by Onera in an EC Dauphin, for a level flight at 85 % of the maximum torque (speed of 140 kt), with 4 inertial actuators (PCB model 712-A02) and accelerometers placed, located on the mechanical deck, close to the 4 gear-box strut connections (figure 37).

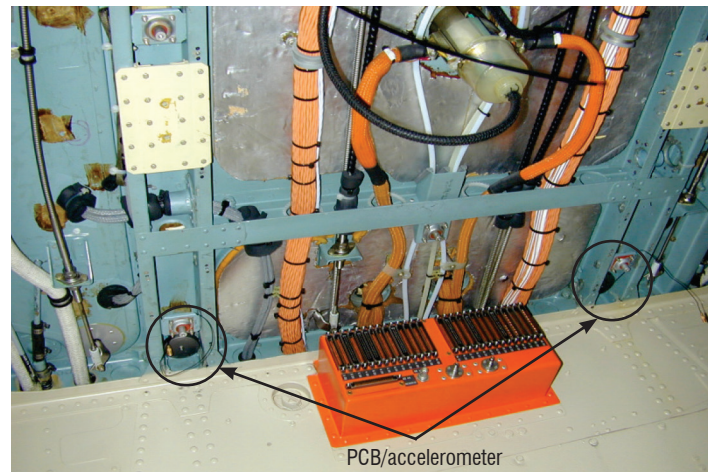

Figure 37 - Installation of inertial actuators with accelerometers placed (Onera)

Thus, an averaged reduction of 3 dB is obtained in the cabin from 6 microphones (i.e., figure 38) at 1074 Hz (Stage 4 of the main gear-box), using 4 SISO FXLMS applied to the accelerometers (for -4.4 dB vibration).

It can be noted that these findings are similar to those obtained by the Politecnico di Milano in an A109A mock-up [21].

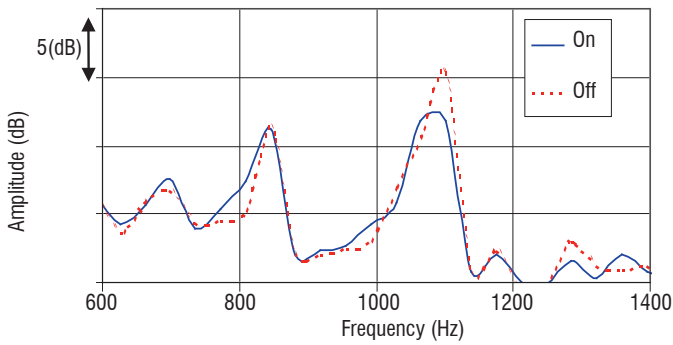

Figure 38 - Example of the acoustic pressure level in a Dauphin cabin (dB - relative value), Control On-Off - Level flight at 85 % of maximum torque (Onera)

Thus, while it is difficult to reduce the cabin noise with the optimization of only one panel (i.e., trim panel under the mechanical deck, as seen previously) because of contributions of other transmission paths, active control applied close to vibration sources ensures a reduction of several dB, even at medium frequencies. Nevertheless, as specified in the introduction, the "hard system added mass / electrical consumption" balance versus "efficiency of control" must be evaluated with industrial requirements.

Panel noise contribution (Microflow)

Although the sound level inside a cabin can be determined rather straightforwardly for a given position, it is harder to assess to which degree each radiating surface contributes to the perceived sound.

As seen previously, Nearfield Acoustic Holography [25] can be applied to estimate the sound radiated from each surface, using an array of sound pressure microphones. However, the radiation can also be determined straightforwardly with a single probe containing a particle velocity sensor. In this section, a procedure involving this sensor is described to measure, not only the radiation, but also the sound pressure contribution of each panel to a listener's position.

Although the history of sound pressure microphones goes back to 1876, it was not until 1994 that a convenient particle velocity sensor called the Microflow was invented [27]. The latter provides a direct measurement of the acoustic particle velocity and can be regarded as a point sensor, due to its sub-millimeter dimensions; much smaller than the wavelength of most frequencies of interest. Microflows are usually combined with a conventional microphone in a so-called PU probe, where P stands for sound pressure and U for acoustic particle velocity. PU probes have been shown to have advantages because of their small size, wide operational frequency range [28] and the direct measurement of particle velocity.

Several unique applications of PU probes emerged over the past decade. Examples of applications for helicopter interior noise are in situ absorption measurements [29], transmission loss measurements without reverberant rooms and panel noise contribution: Contrary to traditional PP sound intensity probes consisting of a pair of microphones, particle velocity measurements in the near field are usually affected little by background noise and reflections [30]. Furthermore, PU probes can be extended easily to full 3D probes and can be used in environments with a high pressure-intensity index [28].

Microflow has shown the potential of its "panel noise contribution" method to measure the sound pressure contributions from certain

interior panels to a reference listening position. The method consists of two parts: the source strength determination and the transfer path determination [31]. The contribution of each radiating section to the sound pressure at the reference position is determined by combining results from the two parts. The synthesized sound pressure at the reference position is finally obtained by summing all sound pressure contributions. The method has been shown to be accurate and fast, compared to existing methods.

Description of the method

The Helmholtz integral equation relates the acoustic pressure and normal velocity on a closed boundary surface S of a vibrating object to the radiated pressure field inside the fluid domain. With this equation, the sound pressure p_r at the reference position can be defined as [31]:

$$p_r = \int_S \left(\frac{p_2}{Q_2} u_{n,1} - \frac{u_2}{Q_2} p_1 \right) dS \quad (3)$$

where $u_{n,1}$ and p_1 are the normal particle velocity and sound pressure, respectively, at the surface boundary. Transfer functions and describe the propagation of sound from surface boundary to the reference position.

In the panel noise contribution method, the normal particle velocity and sound pressure at the surface, and the acoustic transfer functions are measured separately in two steps. First, the radiation of the test article in running conditions is determined. The surface is discretized by dividing it into a number of panels and $u_{n,1}$ and p_1 are obtained by measuring the particle velocity and sound pressure at each panel, with a PU probe. Second, the test article is stopped and the transfer functions from the panel to the reference position are acquired. Usually, it is convenient to determine these transfer function reciprocally, because a direct measurement requires separate tests for each panel with an omni-directional sound source radiating a known volume velocity Q_2 at the panel. Instead, the omni-directional sound source is positioned at the reference position and the resulting sound pressure p_2 and particle velocity u_2 at the panel are measured. This reciprocal approach allows all transfer paths to the panels to be measured at once.

Ultimately, the sound pressure at the reference position is obtained by summing the contributions from all panels. This synthesized sound pressure should equal the sound pressure measured by a microphone during step one, at the reference position. The measurement quality can be checked by comparing both values.

Examples of helicopter tests performed

Panel noise contribution measurements have been performed inside vehicles like cars, aircraft and trains. The following figure shows the results of a test in a Type W3 Swidnick helicopter, with a distributed array of 45 probes [32]. Such results show which panels should be treated to reduce the noise inside the cabin at certain frequencies.

Alternative to measurements at fixed positions, the surface radiation can also be mapped quickly and with high resolution using a scanning technique called Scan & Paint [30]. It involves a probe that is swept across a surface while a video of the measurement set-up is made.

The position of the probe is obtained from the video with dedicated software. The tracking procedure is automated, which speeds up the post-process procedure.

Conclusion

The acoustic characterization of helicopter structures, in terms of Transmission Loss (or a similar parameter), is dealt with differently in laboratories (experiments or simulations on isolated or integrated panels in a cabin). This is also true for approaches to increase the Transmission Loss (passive optimization or active process).

This is the reason why one of the objectives of the "Helicopter Garteur Action Group", devoted to the "design and characterization of composite trim panels", is to apply:

- different types of simulation methods to design and optimize composite trim panels according to common acoustic cost functions and to validate numerical approaches by laboratory tests;
- different types of experimental techniques to characterize composite trim panel acoustic radiation in both a standardized test set-up and a generic helicopter cabin.

These simulations and tests will constitute a benchmark to assess the appropriateness of tools for complex configurations (multiple anisotropic layers with various mechanical characteristics, effect of confined medium on internal noise, etc.). This benchmark will help helicopter manufacturers to select the right tools to simulate or quantify acoustic radiation from vibrating helicopter panels ■

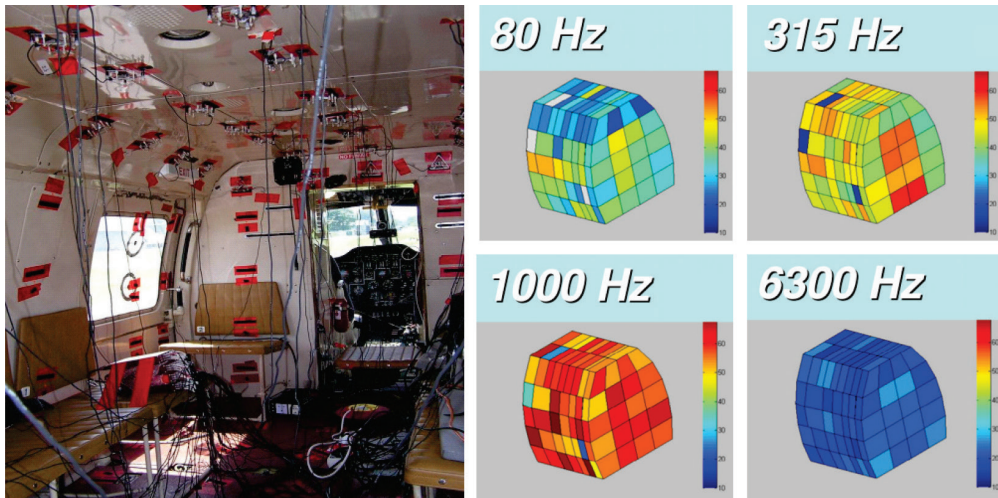

Figure 39 - Helicopter test. Left: probe installation on the roof section. Right: Example of panel contributions (Microflow)

Acknowledgements

We thank the GARTEUR (Group for Aeronautical Research and Technology in Europe) for allowing the cooperation between authors of different laboratories in the helicopter domain (GoR-HC).

Acronyms

ANC	(Active Noise Control)
ASAC	(Active Structural Acoustic Control)
IL	(Insertion Loss)
SPL	(Sound Pressure Level)
TL	(Transmission Loss)

References

- [1] M. WITTING - *Modelling of Diffuse Sound Field Excitations and Dynamic Response Analysis of Lightweight Structures*. Herbert Utz. Verlag, 2000.
- [2] F. FAHY, P. GARDONIO - *Sound and Structural Vibration*. Academic Press, 2nd Ed., 2007.
- [3] F. SIMON, S. PAUZIN, D. BIRON - *Optimisation of Sandwich Trim Panels for Reducing Helicopter Internal Noise*. ERF30, Marseille, France, September 2004.
- [4] Software PIAMCO-V1 (Prévision de l'Indice d'Affaiblissement de Matériaux COmposites) N° IDDN.FR.001.130043.001.S.P.2002.000.30805.
- [5] M. DUSSAC et al. - *A Finite Element Method to Predict Internal Noise Levels at Discrete Frequencies for a Partially Composite Helicopter Fuselage*. Onera T.P. n°1989-49, AHS annual forum, Boston, USA, 1989.
- [6] A.C. NILSSON - *Wave Propagation in and Sound Transmission Through Sandwich Plates*. J. Sound Vib., 138(1), 73-94, 1990.
- [7] F. MARROT, H. SIBOIS - *Panneau insonorisant à cœur souple, procédé de fabrication d'un tel panneau insonorisant*. Patent Application FR08/06.828 filed on December 5th, 2008.
- [8] P. LEITE, M. THOMAS, F. SIMON, Y. BRÉCHET - *Optimal Design of an Asymmetrical Sandwich Panel for Acoustical and Mechanical Properties Using a Genetic Algorithm*. 11th Biennial Conference on Engineering Systems Design and Analysis, Nantes, France, July 2012.
- [9] F. SIMON, S. PAUZIN - *Active Vibration Control of the Acoustic Radiation of a Honeycomb Flat Panel*. Internoise 96, Liverpool, July 1996.
- [10] B. PETITJEAN, I. LEGRAIN, F. SIMON, S. PAUZIN - *Active Control Experiments for Acoustic Radiation Reduction of a Sandwich Panel: Feedback and Feedforward Investigations*. J. Sound Vib., 252 (1),19-36, 2002.
- [11] M. MISOL, S. ALGERMISSEN, H. MONNER - *Experimental Investigation of Different Active Noise Control Concepts Applied to a Passenger Car Equipped with an Active Windshield*. J. Sound Vib., 2012.
- [12] T. HAASE, S. ALGERMISSEN, O. UNRUH, M. MISOL - *Active Control of Counter Rotating Open Rotor Interior Noise*, AIA-DAGA, Merano, Italy, 2013.
- [13] R. H. CABELL, N. H. SCHILLER, F. SIMON - *Application of a Broadband Active Vibration Control System to a Helicopter Trim Panel*. Noise-Con 2013.
- [14] O. HEINZE, M.ROSE, S. ALGERMISSEN, M.MISOL - *Development and Experimental Application of a Pre-Design Tool for Active Noise and Vibration Reduction Systems*. ACTIVE 2009, Ottawa, 2009.
- [15] C. H. PARK, H. C. PARK - *Multiple-Mode Structural Vibration Control Using negative Capacitance Shunt Damping*. KSME International Journal, Vol. 17 No. 11, 1650-1658, 2003.
- [16] C. H. PARK, A. BAZ - *Vibration Control of Beams with Negative Capacitive Shunting of Interdigital Electrode Piezoceramics*. Journal of Vibration and Control 11; 331, 2005.
- [17] M. POHL, M. ROSE, T.HAASE - *Actuator Placement for Shunt Damping of Panel Structures – Numerical Simulation and Experimental Validation*. ICAST, Aruba, 2013.
- [18] F. SIMON, S. PAUZIN - *Structural Intensity Formulation and Measurement Validation in the Case of Composite Multi-Layered Structures*. Acta Acustica, Vol. 92(2), 2006.
- [19] NF EN ISO 3741 (S 31 022) - *Determination of Sound Power Levels of Noise Sources Using Sound Pressure - Precision Methods for Reverberation Rooms*, 2000.
- [20] ISO 9614-1 - *Determination of Sound Power Levels of Noise Sources Using Sound Intensity - Part 1: Measurement at Discrete Points*. 1993.
- [21] W. CORBETTA, E. VIGONI, A. TOSO, G.L. GHIRINGHELLI, L. DOZIO, F. CENEDESE - *Active Control of Helicopter's Gearbox Vibrations and Effects on the Cabin Noise*. 34th European Rotorcraft Forum 2008 (ERF34) , Liverpool, UK, 16-19 Sept. 2008, ISBN: 9781617821998, p. 2297-2326, Paper_10a2
- [22] F. SIMON, S. PAUZIN, D. BIRON - *Modelization and Test of Composite Trim Panels for Reducing Helicopter Internal Noise*. ICSV9 - 9th International Congress on Sound and Vibration, Orlando, USA, July 2002.
- [23] E. JULLIARD, F. SIMON, S. PAUZIN, D. BIRON - *Acoustic Localization into a Generic Helicopter Cabin*. Euronoise 2006, Tampere, USA, may 2006.
- [24] G. MARTIN, F. SIMON, D. BIRON - *Detection of Acoustic Radiating Areas of a Generic Helicopter Cabin by Beamforming*. Acoustics '08, Paris, France, July 2008.
- [25] J. CAILLET, F. MARROT, Y. UNIA, P-A. AUBOURG - *Comprehensive Approach for Noise Reduction in Helicopter Cabins*. Aerospace Science and Technology 23, 17–25, 2012.
- [26] F. GAUDAIRE, N. NOE - *ICARE - Notice Technique*. CSTB, 15 Mars 2004.
- [27] H.E. DE BREE, P. LEUSSINK, T. KORTHORST, H. JANSEN, T. LAMMERINK AND M. ELWENSPOEK - *The Microflown; a Novel Device Measuring Acoustic Flows*. Sensors and Actuators. 54 (1-3), 552-557. ISSN 0924-4247, 1996.
- [28] F. JACOBSEN, H.E. DE BREE - *A Comparison of Two Different Sound Intensity Measurement Principles*. Journal of the Acoustical Society of America. 118 (3), 1510-1517. ISSN 0001-4966, 2005.
- [29] J.D. ALVAREZ, F. JACOBSEN - *An Iterative Method for Determining the Surface Impedance of Acoustic Materials In Situ*. Internoise. 2008.
- [30] H.E. DE BREE, W. DRUYVESTYEN - *A Particle Velocity Sensor to Measure the Sound from a Structure in the Presence of Background Noise*. Forum Acusticum conference. Budapest. Hungary, 2005.
- [31] O. WOLFF - *Fast Panel Noise Contribution Analysis Using Large PU Sensor Arrays*. Internoise. 2007.
- [32] O. WOLFF, H.E. DE BREE, J. DE BOER, W. HAKE - *In-Flight Panel Noise Contribution Analysis on a Helicopter of Type W3*. Technical Report www.microflown.com, 2008.



Frank Simon, graduated from ENSICA Toulouse with a degree in Aeronautical Engineering (1989), from Supaero Toulouse with a PhD in Mechanical Engineering (Acoustics) (1997) and from the University of Toulouse with Authorization to supervise PhD students (2007). Research Master at Onera, specialized in the development of vibro-acoustic modelizations and measurement techniques, participation in various EC projects in the vibro-acoustic domains (RHINO, FACE, FRIENDCOPTER), in charge of internal noise in the Garteur group.



Thomas Haase graduated from Otto-von-Guericke University in Magdeburg in 2010, with a Diploma in Mechatronics. He joined the German aerospace center (DLR) in 2010 and is currently a scientist. His main interests are signal processing for active control and actuator/sensor placement for active structural acoustic control. He is an author of papers published in the conference proceedings of the 19th International Conference of Sound and Vibration (ICSV19) and the AIA-DAGA 2013 Conference on Acoustics 2013.



Oliver Unruh graduated from TU Berlin with a degree in Aerospace Engineering. He joined the German Aerospace Center (DLR) in 2009 and is currently working in the Department of Composite Structures and Adaptive Systems. He is part of a research group that deals with the design and realization of adaptive systems for active structural acoustic control. His research mainly concerns simulation methods in structural acoustics and sound propagation/radiation.



Martin Pohl graduated from TU Dresden in 2008 and joined the DLR in the same year. He currently works as a scientist focused on adaptive systems in structural dynamics, acoustics and electronics. There, he investigates piezoelectric shunt damping of shell structures for noise and vibration reduction of aircraft structures. He has published papers in the proceedings of ISMA, EURONOISE, ICAST and SMASIS conferences.



Emiel Tijts obtained his bachelor's degree in mechanical engineering at the Saxion Hogeschool Enschede in 2004 and has been working at Microflown Technologies ever since. He obtained his PhD developing an in situ method to measure sound absorption at Twente University in 2013. He is mainly involved in further developing sensors and applications for sound source localization and quantification, characterization of sound absorbing materials and underwater testing.



Rik Wijntjes graduated from Delft University in 2008, with a Master's degree in Applied Physics. He joined the National Aerospace Laboratory (NLR) in 2012 and is currently a R&D Engineer in Aeroacoustics, primarily involved in testing wall mounted sound absorbing materials. During these tests, the air flow effects over the surface of sound absorbing materials used in turbofan engine intake and exhaust ducts are simulated.



Henk van der Wal graduated from the University of Twente in 1973, with a Master's degree in Mathematics and informatics. He joined the National Aerospace Laboratory (NLR) in 1985 as a R&D Engineer in Aeroacoustics and retired in 2013. During his career he became an expert in the fields of noise insulation (aircraft fuselage barrels) and engine liner material testing. He has been the project manager of a large number of international (multi-partner) projects at the NLR and the work package leader for large European projects.



Gian Luca Ghiringhelli graduated from the Politecnico di Milano in Aeronautic Engineering (1980); He is a full professor at the Politecnico di Milano, in the Department of Aerospace Science and Technology. His past research fields include: structural dynamics and aeroelasticity, helicopter rotor modeling and analysis, aircraft design, composite structures, modeling and testing of smart structures (piezoelectric), and multibody modeling of complex systems; His current research fields include: vibration and noise in helicopters and aircraft (modelization and testing, materials and structures), active control and smart structures and materials (Piezo and MRF), and landing gear modeling and testing. Participation in the EC project FRIENDCOPTER.